

RWM 1600 E - Bestell-Nr. 31610290OAFa

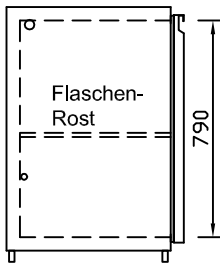

CNS-Flaschenrost
mit Stellschienen
Best.-Nr.: 3500

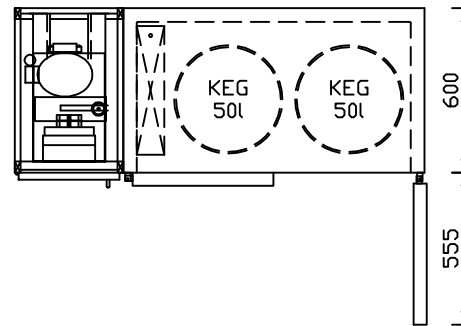
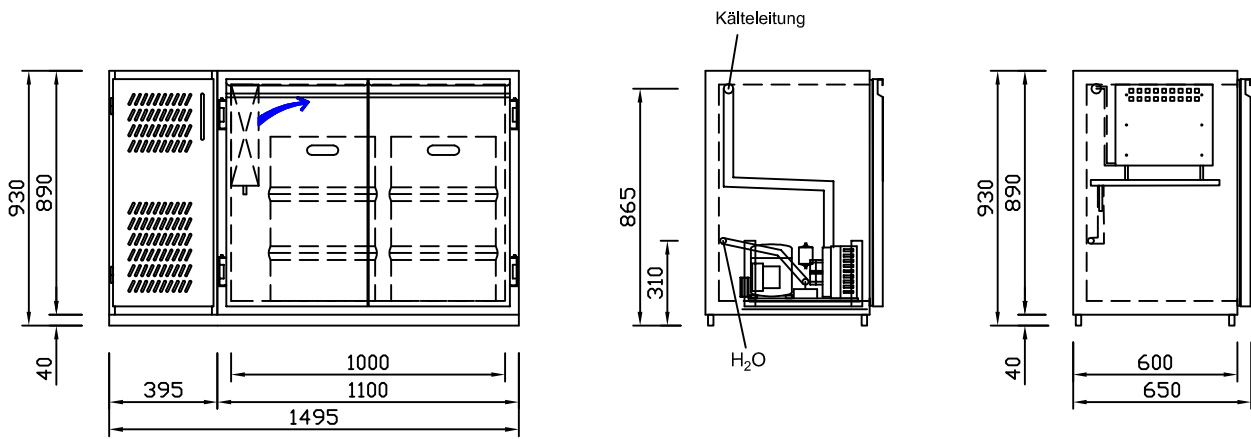
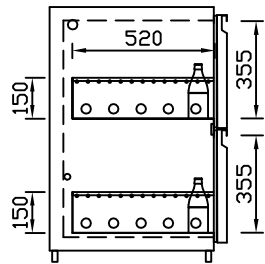

EZ-35/35
Doppelauszug 1/2-1/2
Best.-Nr.: 30210

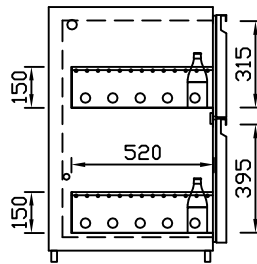

EZ-31/39
Doppelauszug 1/3-2/3
Best.-Nr.: 30110

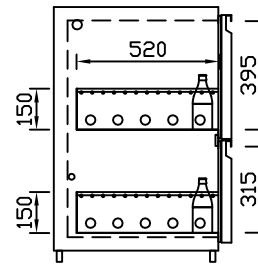

EZ-39/31
Doppelauszug 2/3-1/3
Best.-Nr.: 30120

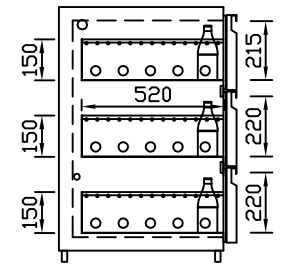

EZ-22/22/22
Dreierauszug 3/3
Best.-Nr.: 30300