

RWM 2100 E - Bestell-Nr. 32110290OAF

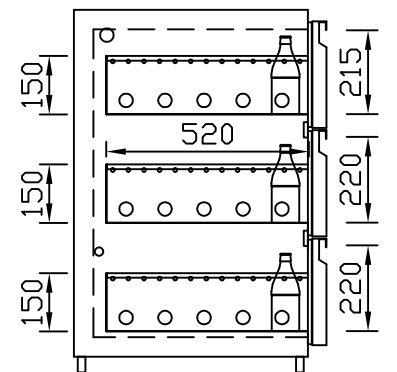
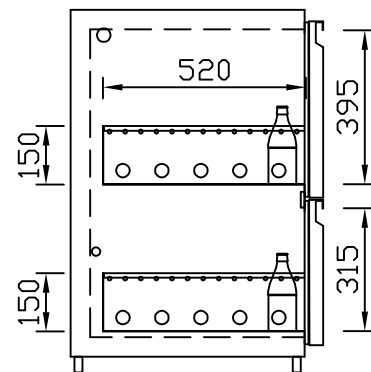
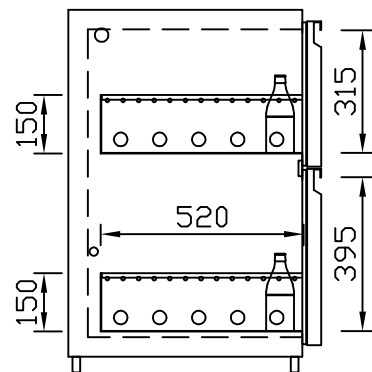
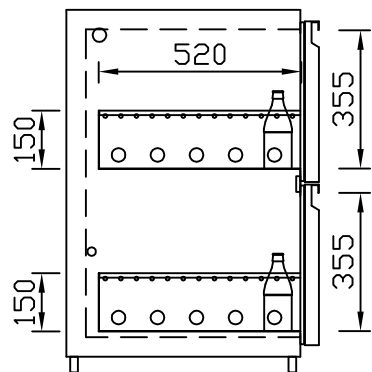
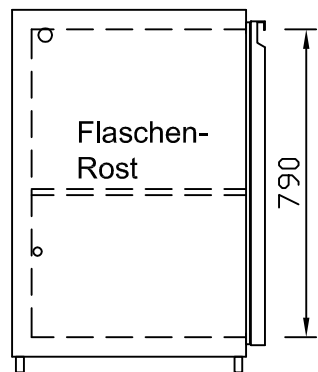
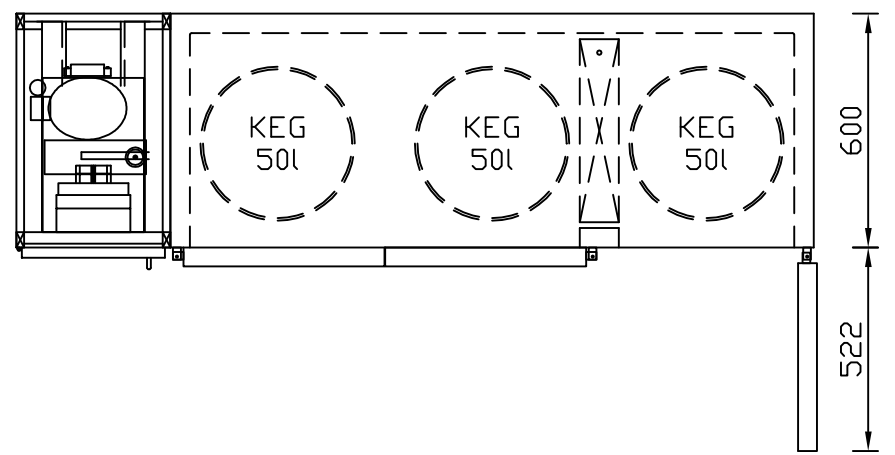
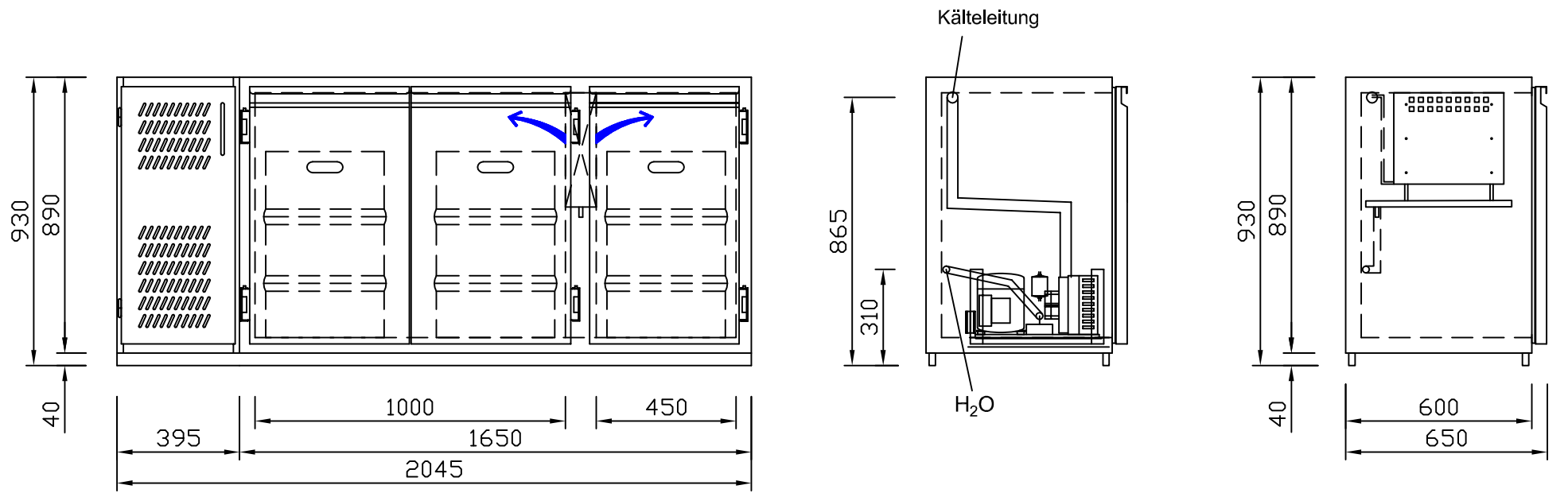

CNS-Flaschenrost
mit Stellschienen
Best.-Nr.: 3500

EZ-35/35
Doppelauszug 1/2-1/2
Best.-Nr.: 30210

EZ-31/39
Doppelauszug 1/3-2/3
Best.-Nr.: 30110

EZ-39/31
Doppelauszug 2/3-1/3
Best.-Nr.: 30120

EZ-22/22/22
Dreierauszug 3/3
Best.-Nr.: 30300