

# RWM 2500 E - Bestell-Nr. 32522290

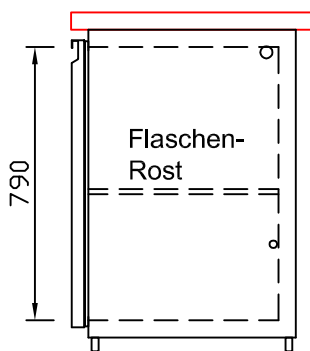

CNS-Flaschenrost  
mit Stellschienen  
**Best.-Nr.: 3500**

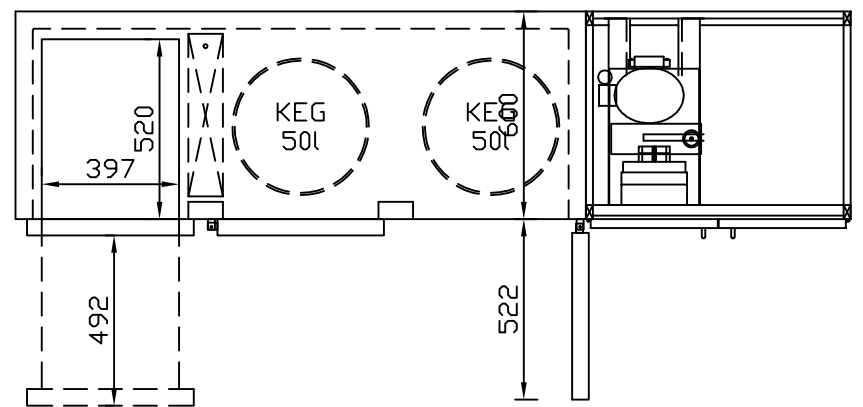
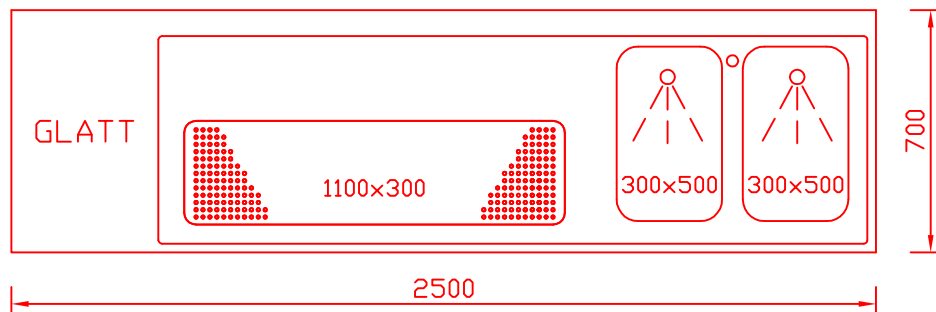
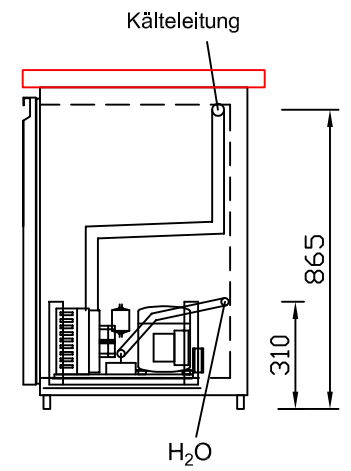
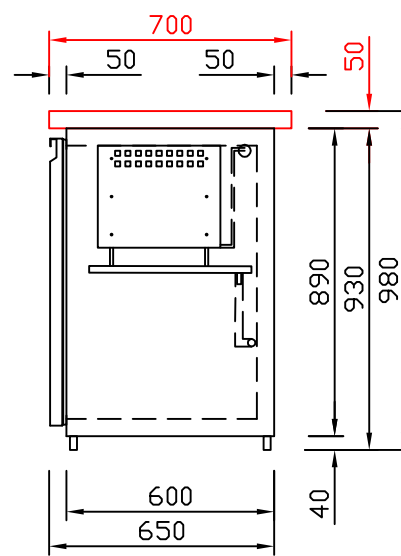
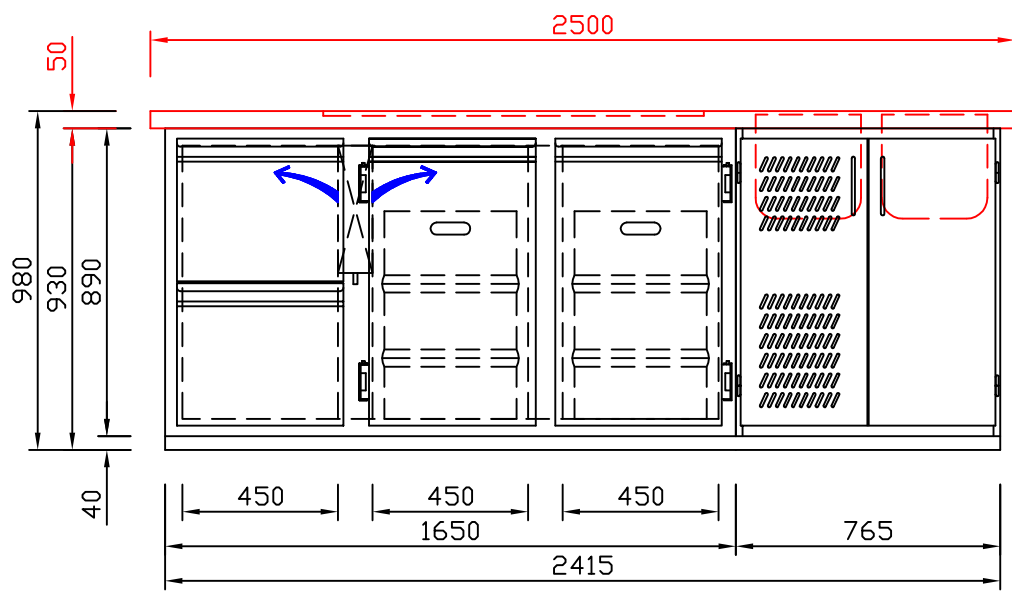
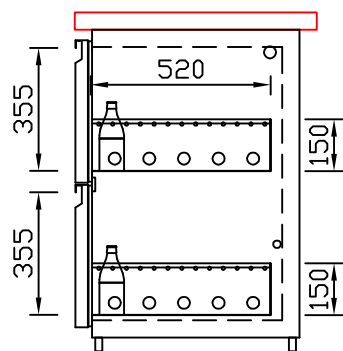

EZ-35/35  
Doppelauszug 1/2-1/2  
**Best.-Nr.: 30210**

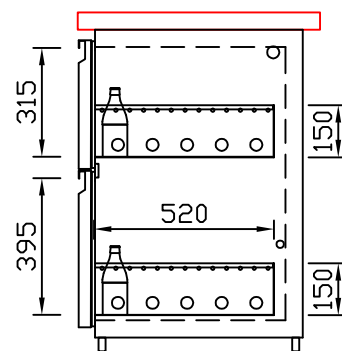

EZ-31/39  
Doppelauszug 1/3-2/3  
**Best.-Nr.: 30110**

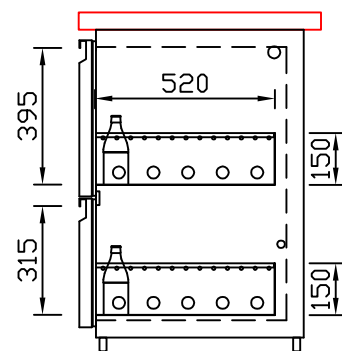

EZ-39/31  
Doppelauszug 2/3-1/3  
**Best.-Nr.: 30120**

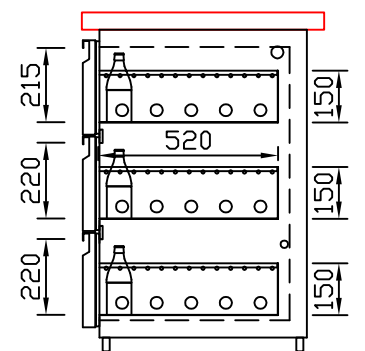

EZ-22/22/22  
Dreierauszug 3/3  
**Best.-Nr.: 30300**