

RWM 3050 E - Bestell-Nr. 33125290FA

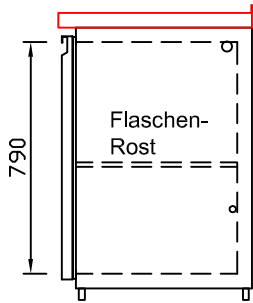

CNS-Flaschenrost  
mit Stellschienen  
Best.-Nr.: 3500

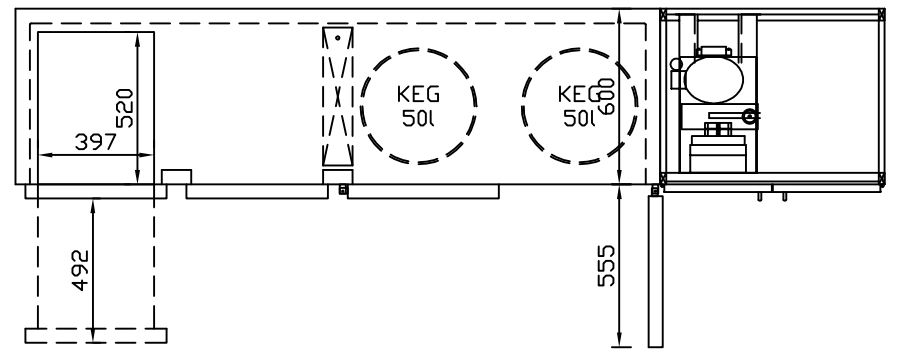
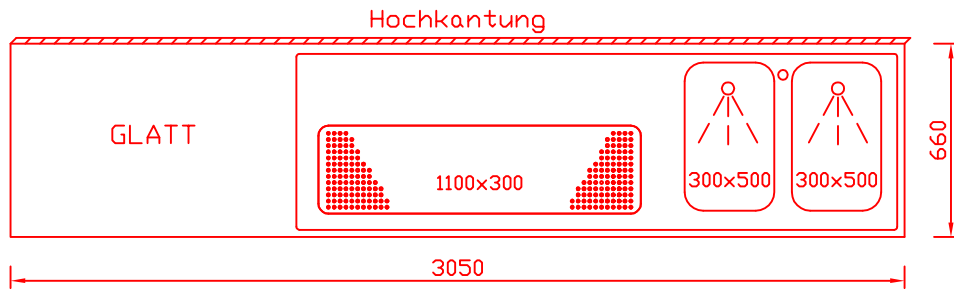
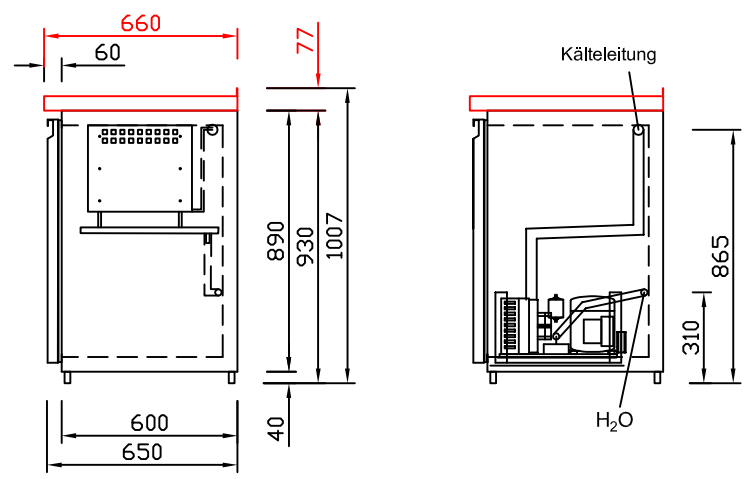
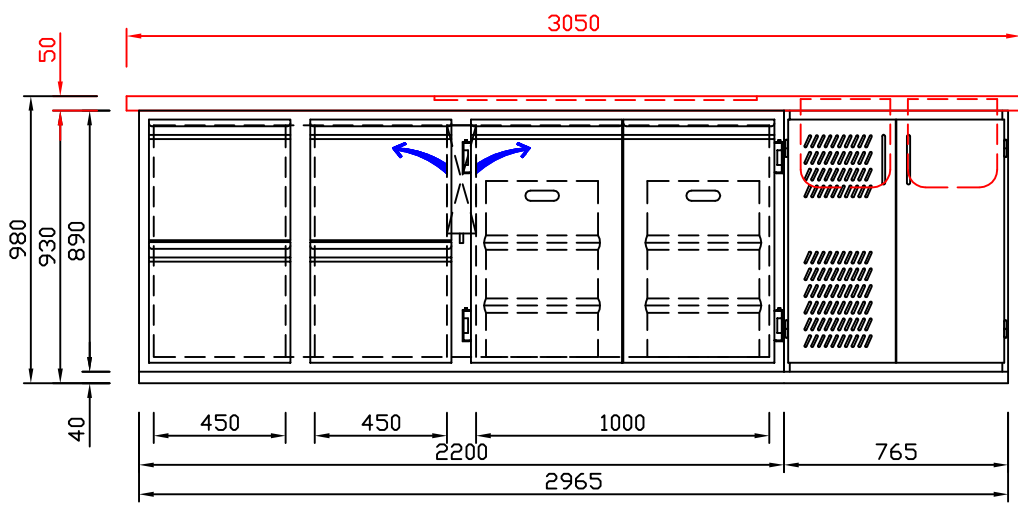
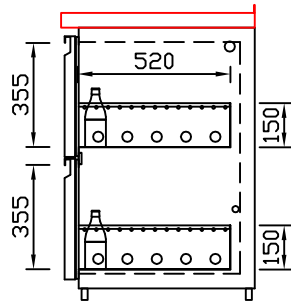

EZ-35/35  
Doppelauszug 1/2-1/2  
Best.-Nr.: 30210

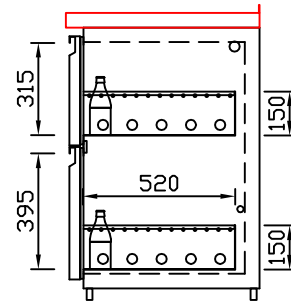

EZ-31/39  
Doppelauszug 1/3-2/3  
Best.-Nr.: 30110

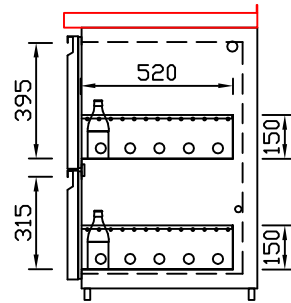

EZ-39/31  
Doppelauszug 2/3-1/3  
Best.-Nr.: 30120

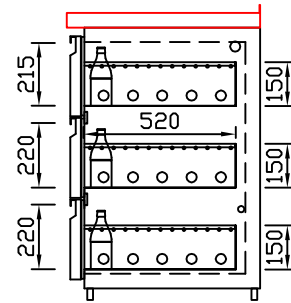

EZ-22/22/22  
Dreierauszug 3/3  
Best.-Nr.: 30300