

# RWM 2500 G - Bestell-Nr. 42515290

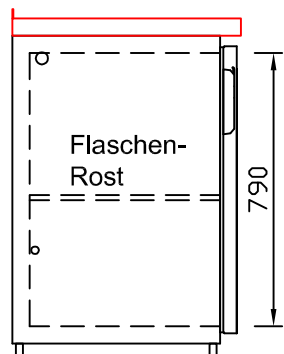

CNS-Flaschenrost  
mit Stellschienen  
**Best.-Nr.: 3500**

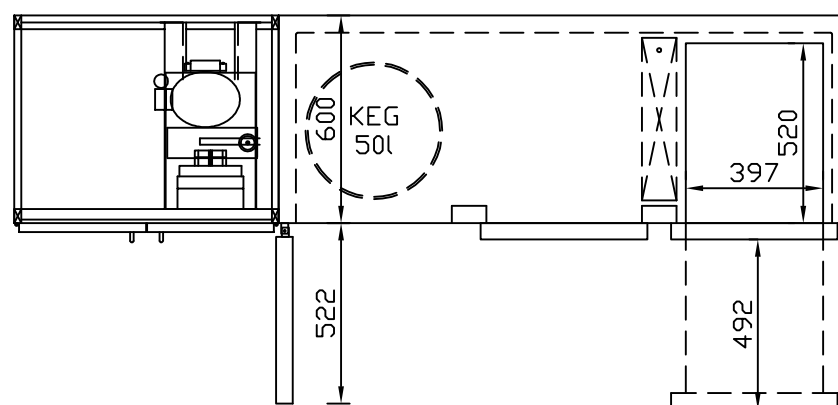
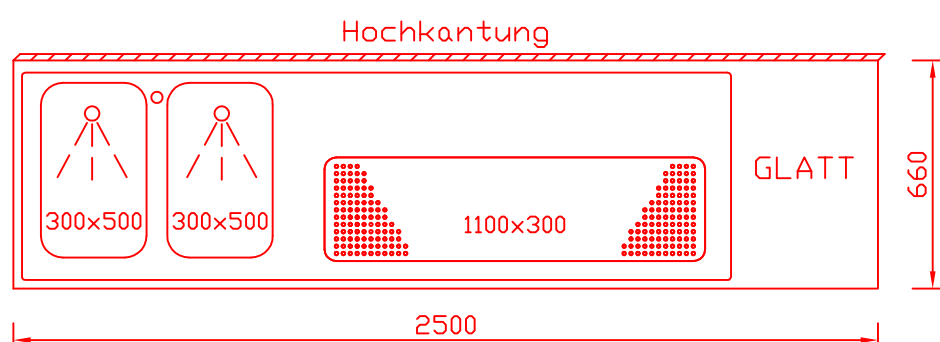
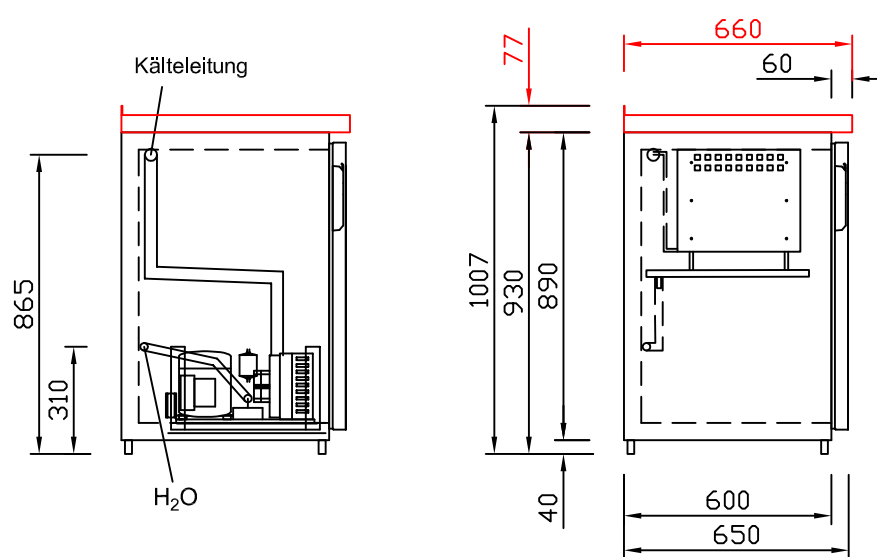
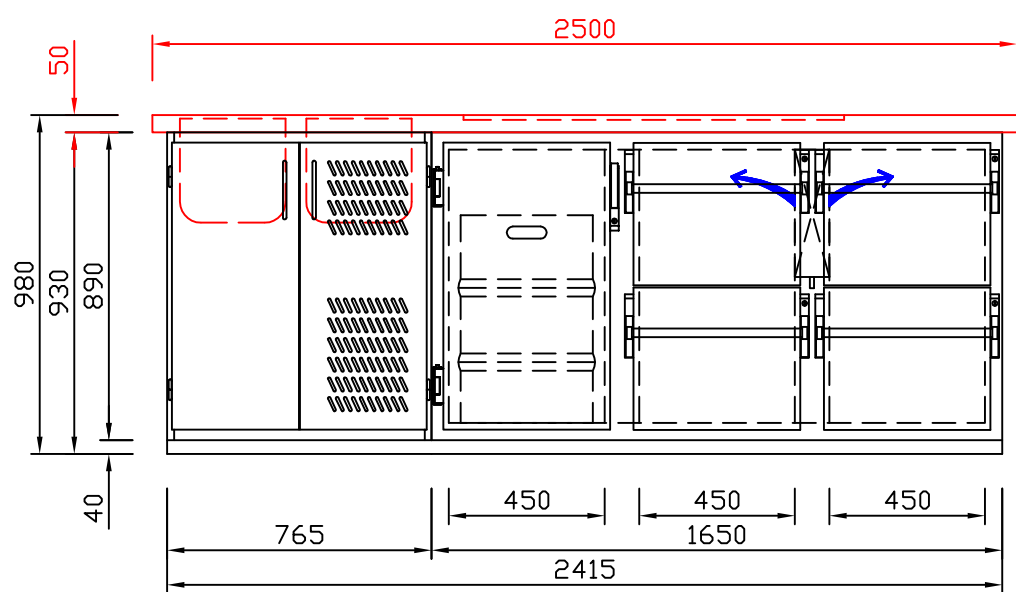
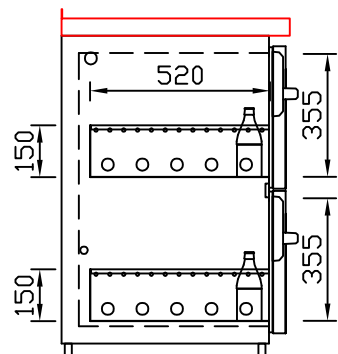

GZ-35/35  
Doppelauszug 1/2-1/2  
**Best.-Nr.: 40210**

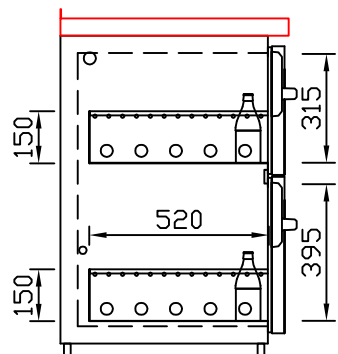

GZ-31/39  
Doppelauszug 1/3-2/3  
**Best.-Nr.: 40110**

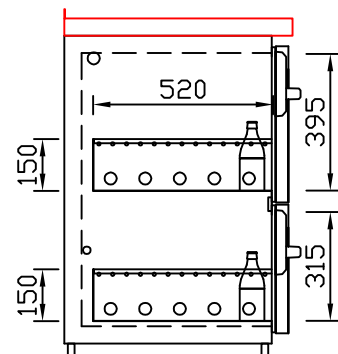

GZ-39/31  
Doppelauszug 2/3-1/3  
**Best.-Nr.: 40120**

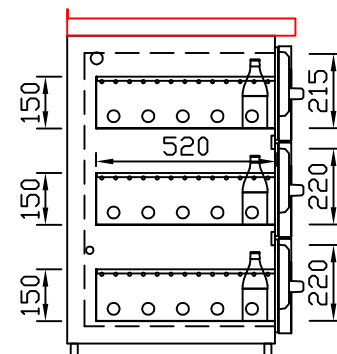

GZ-22/22/22  
Dreierauszug 3/3  
**Best.-Nr.: 40300**