

RWM 3050 G - Bestell-Nr. 43116290

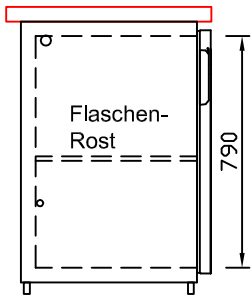

CNS-Flaschenrost
mit Stellschienen
Best.-Nr.: 3500

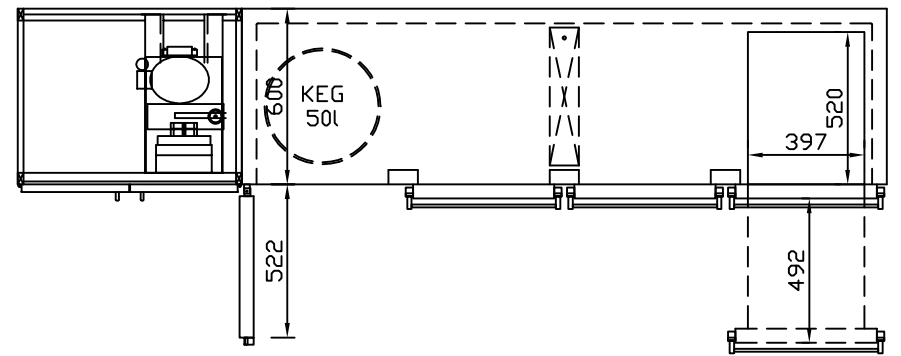
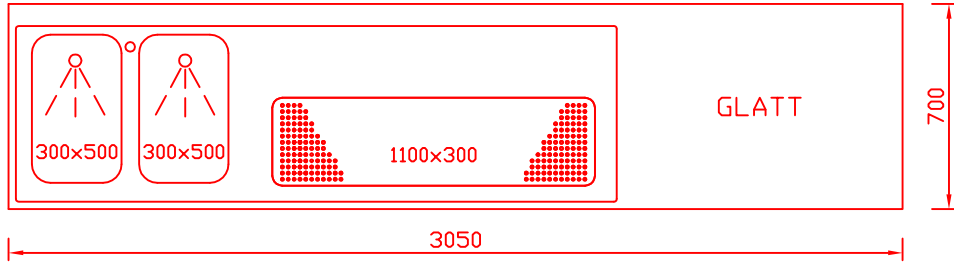
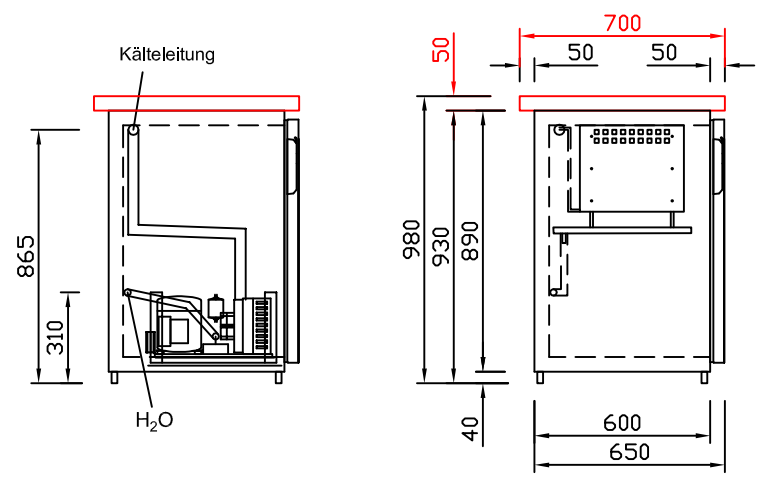
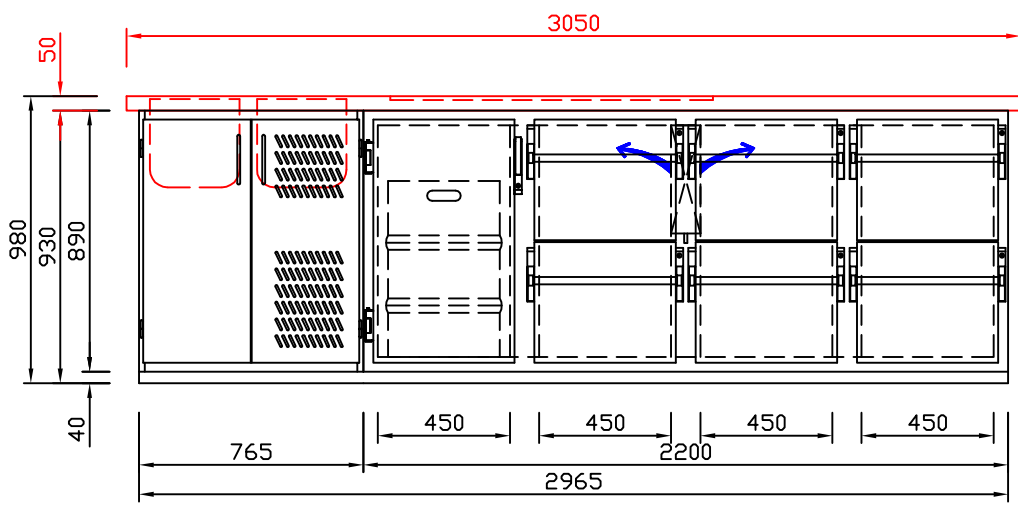
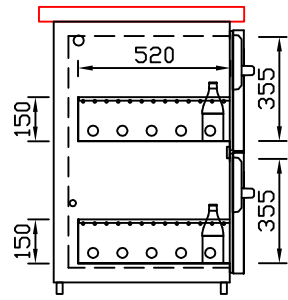

GZ-35/35
Doppelauszug 1/2-1/2
Best.-Nr.: 40210

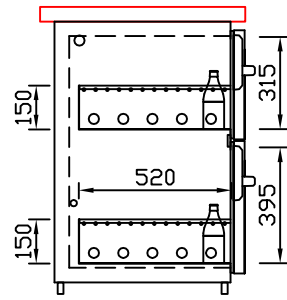

GZ-31/39
Doppelauszug 1/3-2/3
Best.-Nr.: 40110

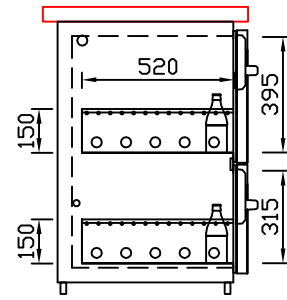

GZ-39/31
Doppelauszug 2/3-1/3
Best.-Nr.: 40120

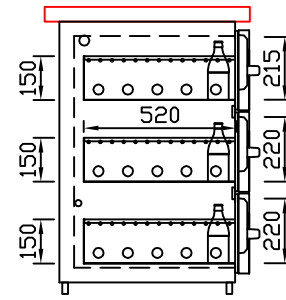

GZ-22/22/22
Dreierauszug 3/3
Best.-Nr.: 40300